

Marat 44

Plan

План

Стена B
Wall B
Mur B
Wand B

Стена E
Wall E
Mur E
Wand E

Стена D
Wall D
Mur D
Wand D

16.7 m²

Стена C
Wall C
Mur C
Wand C

Стена A
Wall A
Mur A
Wand A

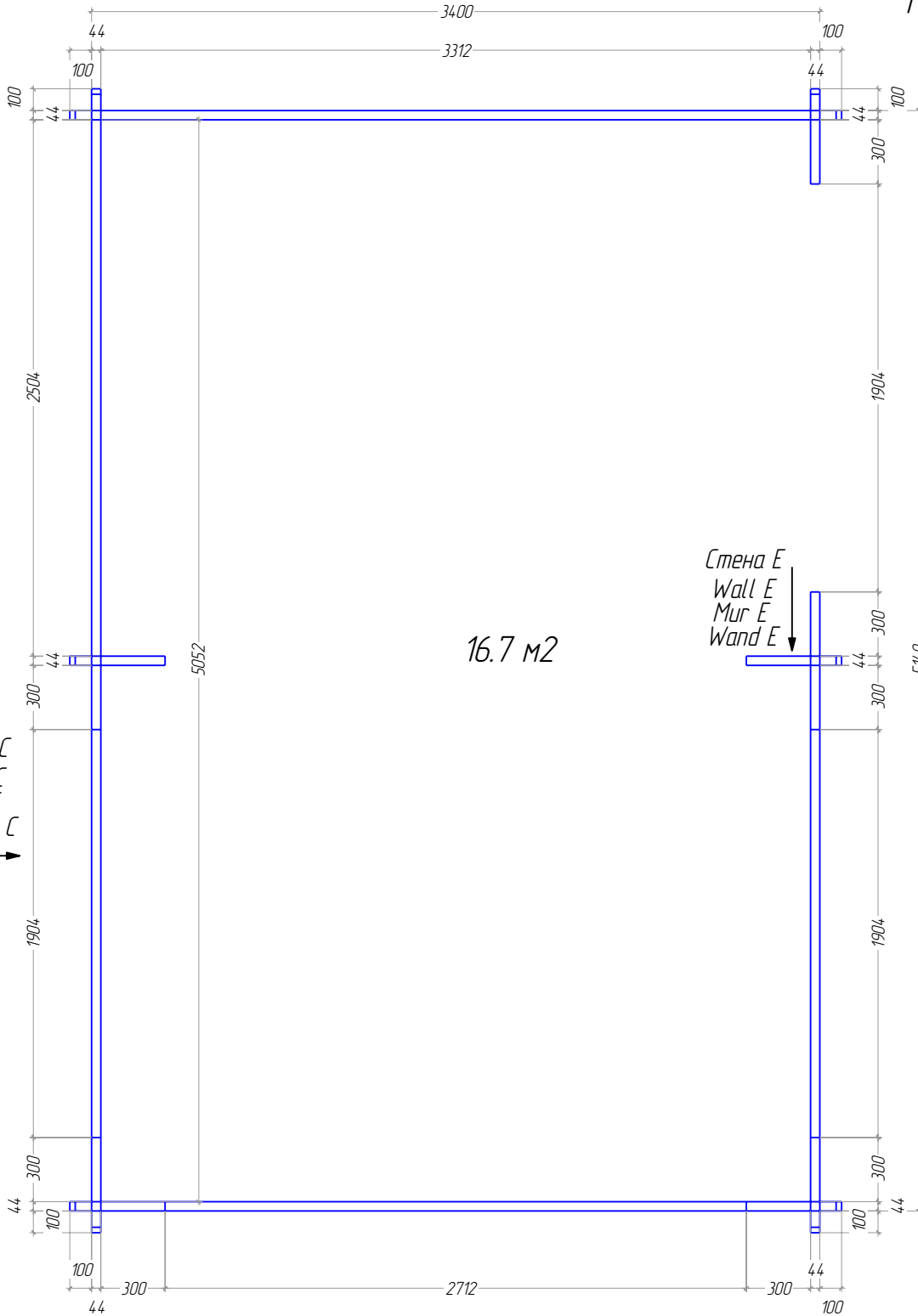





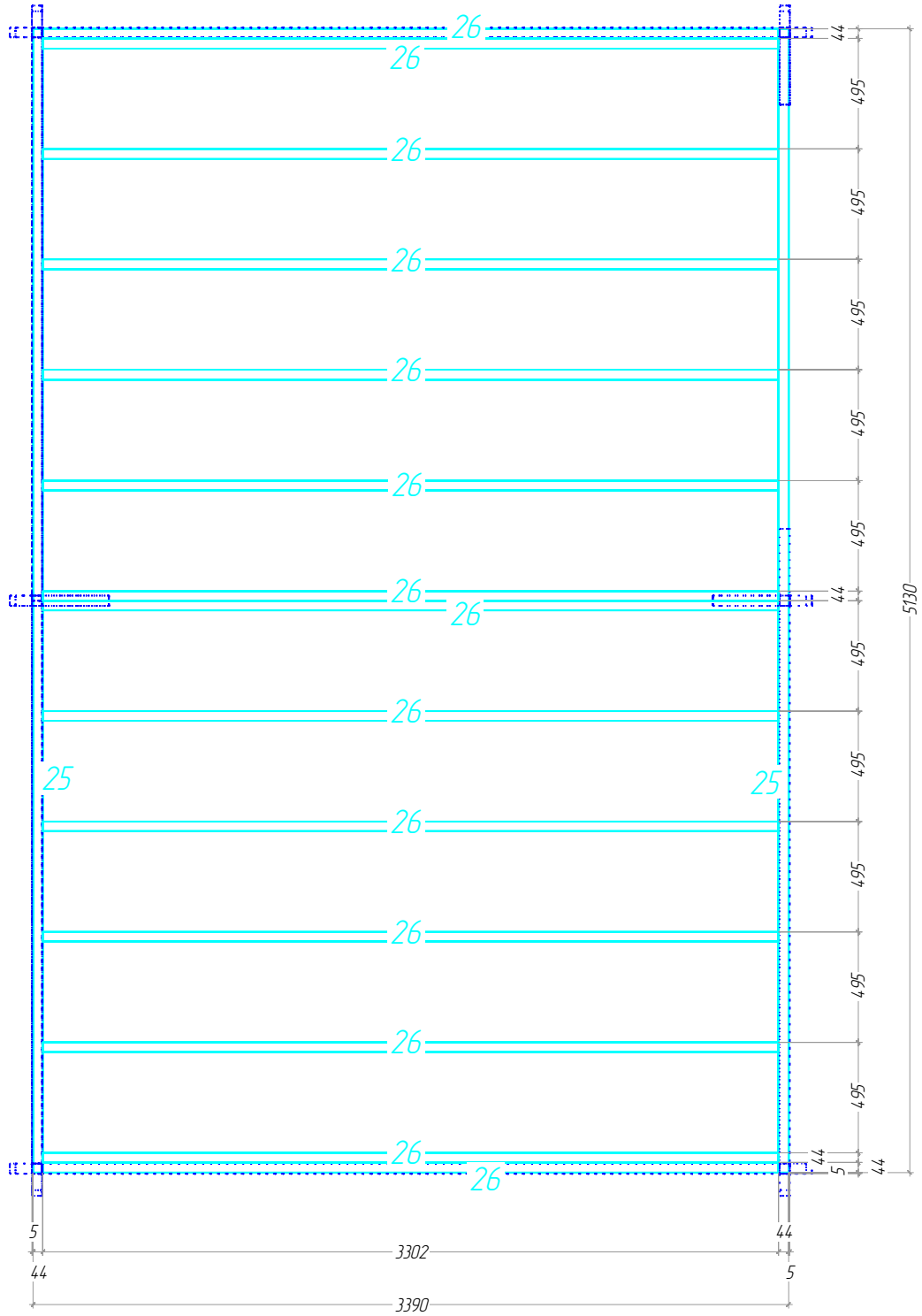

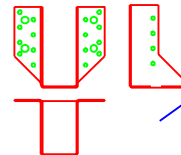
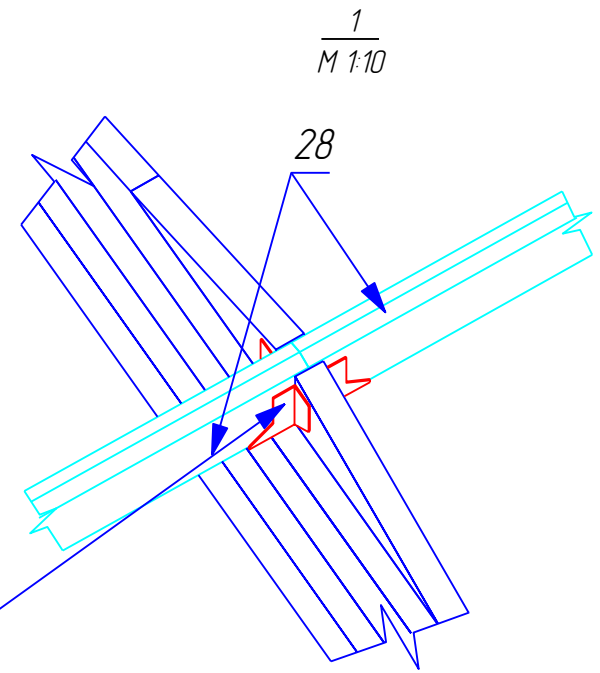
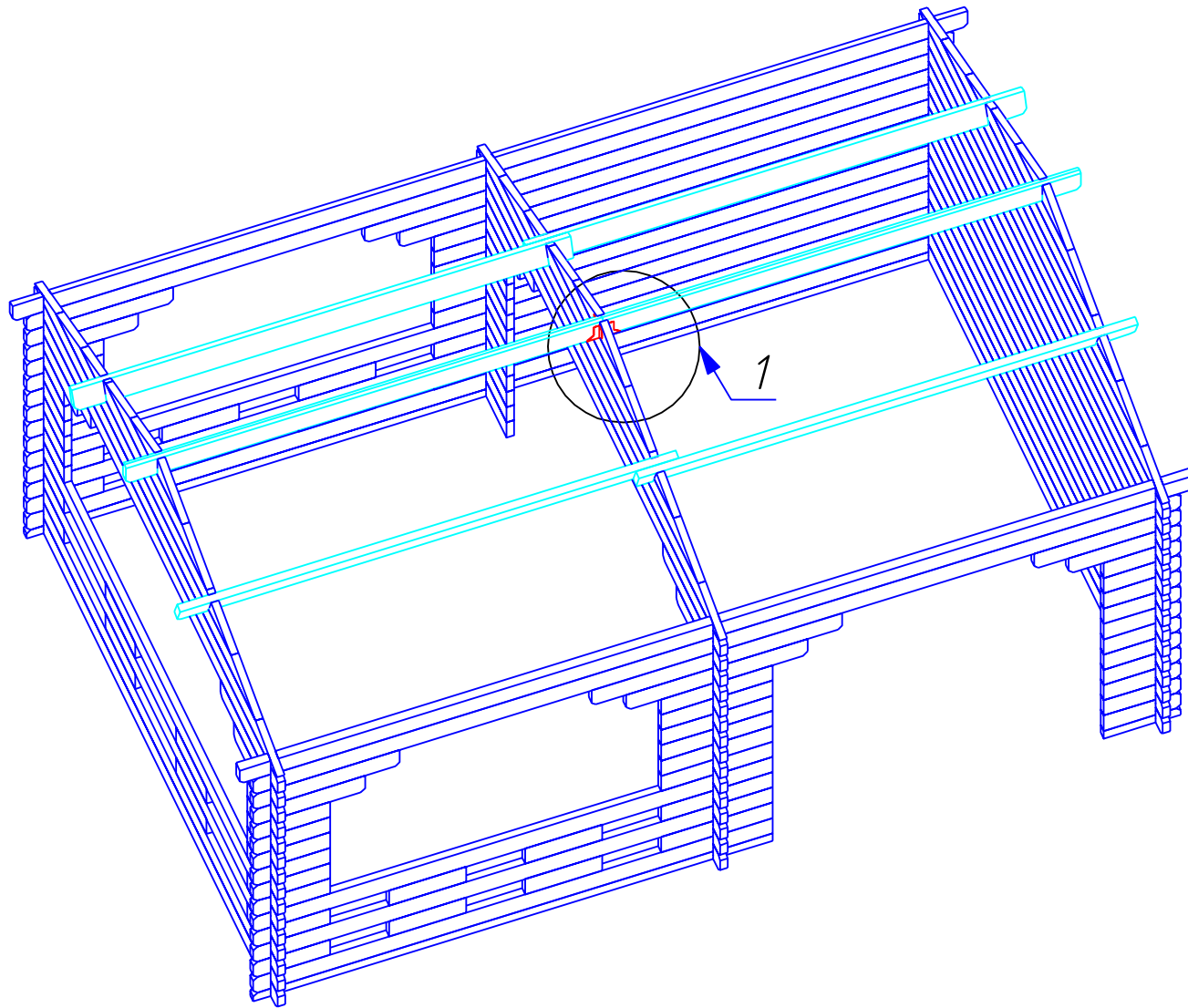

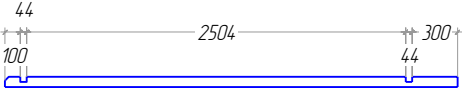
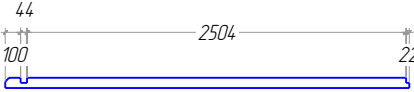

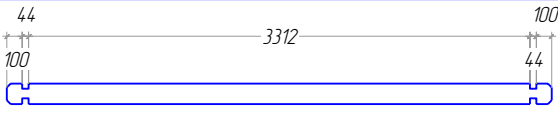
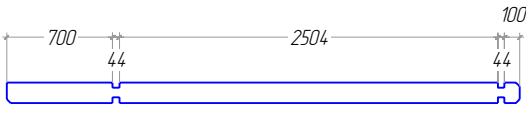
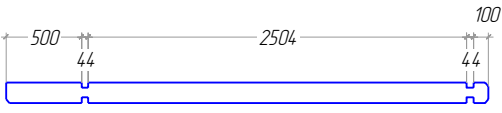
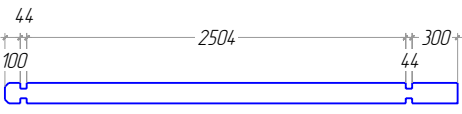
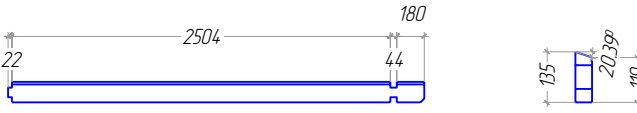
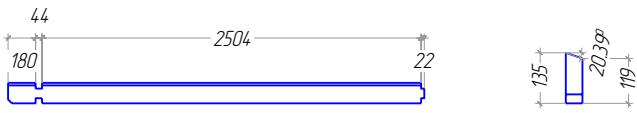
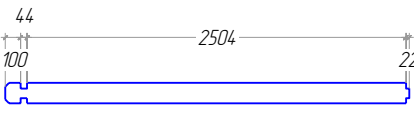
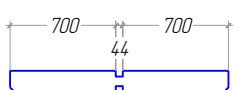
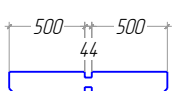
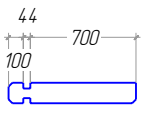

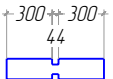
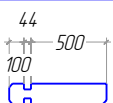
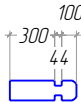
Марат 44



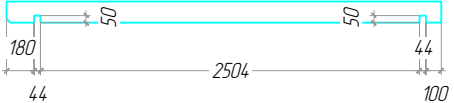
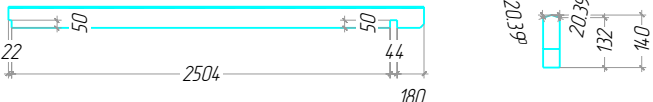





План лаг

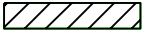

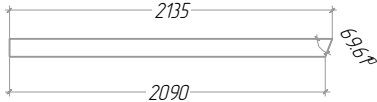

| Nº | Marat 44 | Nr. | Profile (mm) | Lenght (mm) |
|----|--|------|--------------|-------------|
| 1 |  | 1 | 44x67,5 | 2992mm |
| 2 |  | 2 | 44x67,5 | 2670mm |
| 3 |  | 1 | 44x67,5 | 444mm |
| 4 |  | 21+1 | 44x135 | 3600mm |
| 6 |  | 1 | 44x135 | 3392mm |
| 7 |  | 1 | 44x135 | 3192mm |
| 8 |  | 11 | 44x135 | 2992mm |
| 10 |  | 2 | 44x135 | 2750mm |
| 11 |  | 2 | 44x135 | 2750mm |
| 12 |  | 10 | 44x135 | 2670mm |
| 17 |  | 1 | 44x135 | 1444mm |
| 18 |  | 1 | 44x135 | 1044mm |
| 19 |  | 7 | 44x135 | 844mm |

| Nº | Marat 44 | Nr. | Profile (mm) | Lenght (mm) |
|----|--|------|--------------|-------------|
| 21 |  | 8 | 44x135 | 644mm |
| 22 |  | 7 | 44x135 | 644mm |
| 23 |  | 67 | 44x135 | 444mm |
| 24 |  | 12 | 44x135 | 444mm |
| 25 |  | 2 | 44x68 | 5130mm |
| 26 |  | 14 | 44x68 | 3302mm |
| 27 |  | 4 | 44x140 | 2872mm |
| 28 |  | 2 | 44x140 | 2750mm |
| 29 |  | 50+1 | 20x115 | 2524mm |
| 30 |  | 9 | 20x115 | 2500mm |
| 31 |  | 2 | 20x18 | 3312mm |
| 32 |  | 3 | 20x18 | 2504mm |
| 33 |  | 6 | 20x18 | 300mm |

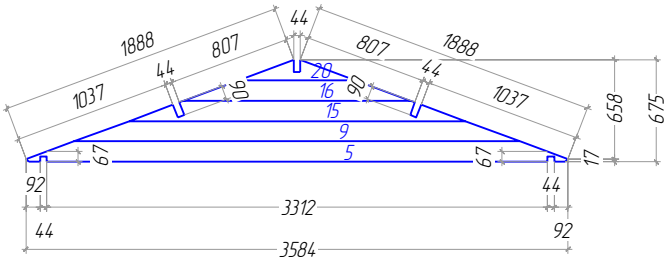
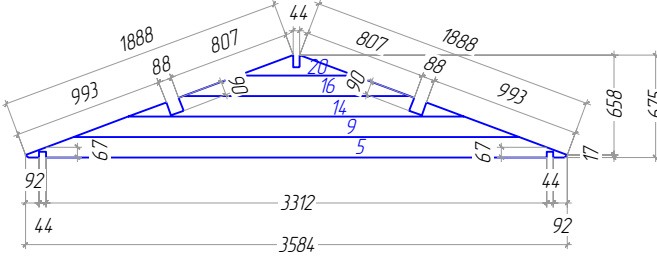
| № | Marat 44 | Nr. | Profile (mm) | Lenght (mm) |
|-----|--|------|--------------|-------------|
| 34 |  | 4 | 17x90 | 2750mm |
| 35 |  | 96+1 | 20x115 | 2080mm |
| 36 |  | 4 | 20x120 | 2135mm |
| 37 |  | 1 | 20x58 | 2712mm |
| 38 |  | 2 | 20x58 | 1904mm |
| 39 |  | 4 | 20x58 | 2125mm |
| 40 |  | 6 | 28x34 | 1833mm |
| 41 |  | 2 | 20x120 | 120mm |
| W-1 |  | 1 | | |
| W-2 |  | 1 | | |

| № | Marat 44 | Nr. | Profile (mm) | Lenght (mm) |
|-----|----------|-----|--------------|-------------|
| W-3 | | 1 | | |

